

# Data Sheet

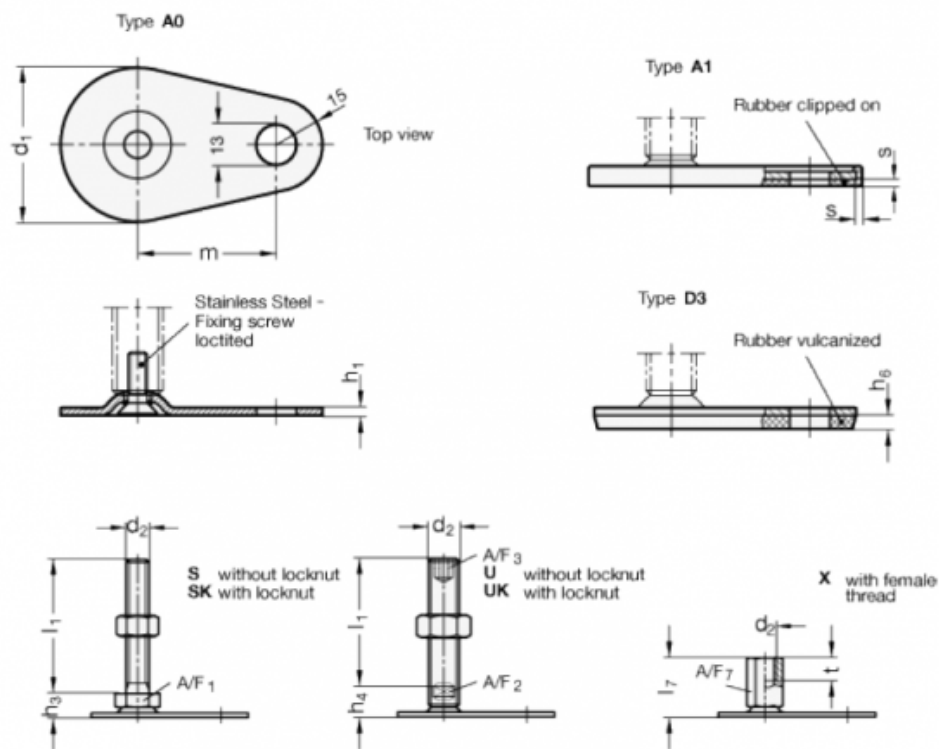

Article number: 204250M10100D3SK  
 Description: E+G levelling foot  
 GN 42-50-M10-100-D3-SK  
 Note: SK With nut, External hexagon at the bottom

## Measures



A/F1 = 17  
 $d_1$  = 50  
 $d_2$  = M10  
 $h_1$  = 2.5  
 $h_3$  = 11  
 $h_6$  = 4  
 $h_1$  = 100  
 $m$  = 45

s =